

Elitech[®]

Innovation Preceding All

Smart Temperature Controller Series STC-1000Pro/STC-1000WiFi User Manual

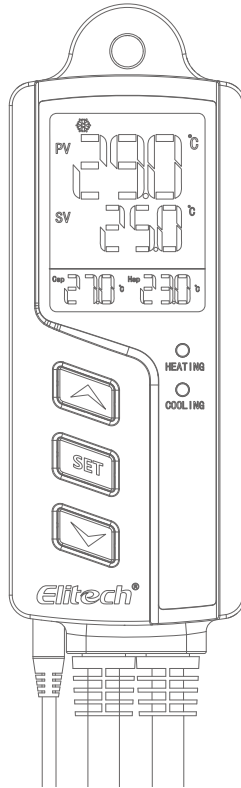

Smart Digital Thermostat
No wiring , No hassle

CONTENTS

Smart Temperature Controller Series STC-1000Pro/STC-1000WiFi User Manual	1-11
Intelligente Temperaturregler-Serie STC-1000Pro/STC-1000WiFi Benutzerhandbuch	12-22
Serie del controlador de temperatura inteligente Manual de uso de STC-1000Pro/STC-1000WiFi	23-33
Série de thermostat intelligent Mode d'emploi STC-1000Pro/STC-1000WiFi	34-44
Serie di Termostati Intelligenti Manuale di istruzione di modello STC-1000Pro/STC-1000WiFi	45-55
A Série de Controlador Inteligente de Temperatura Manual de Instruções de STC-1000Pro/STC-1000WiFi	56-66
Интеллектуальный термоконтроллер серии ИНСТРУКЦИЯ по эксплуатации	67-77

1.0 Overview

STC-1000Pro/STC-1000WiFi is a plug-and-play smart digital temperature controller. It features two pre-wired heating and cooling outlets that not only can keep your appliances at ideal temperatures automatically but also can keep safe and reliable due to the usage of V-0 classified flame-retardant ABS materials. Meanwhile, its three-button design and 2.5" LCD give intuitive temperature viewing and parameters settings, such as high/low temperature alarm, temperature calibration, °C/°F unit switch, cooling protection time, etc.. where STC-1000WiFi is a wireless controller that supports more function via the Elitech app.

STC-1000Pro/STC-1000WiFi with UK/EU/US version can be widely used in areas that need automatic temperature controls such as homebrew, aquarium, incubation, pet breeding, seedling heat mats, culture fermentation, etc.

In the box

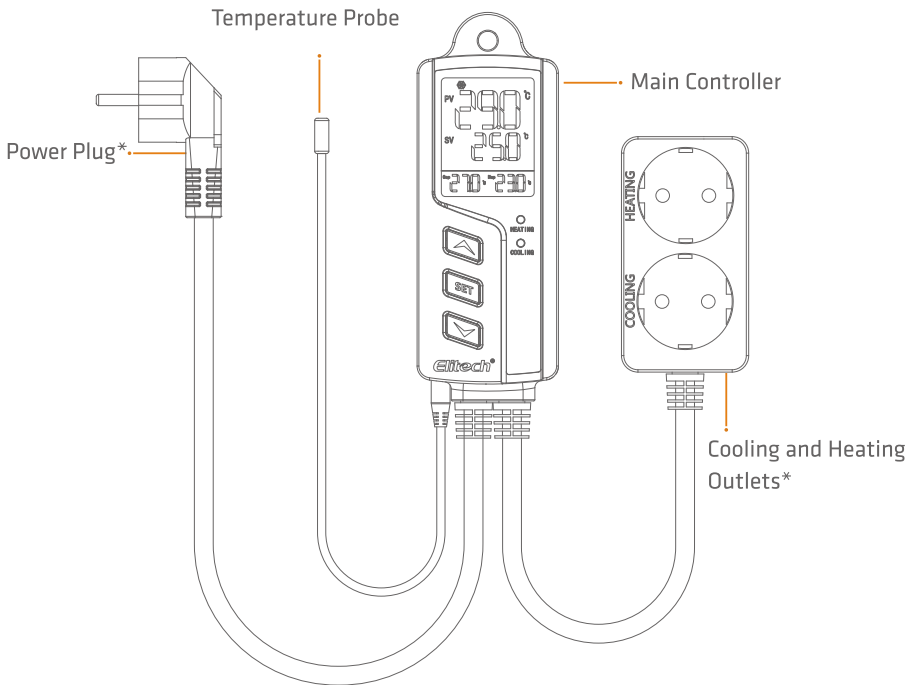

* Available in UK/EU/US version

1.1 Display

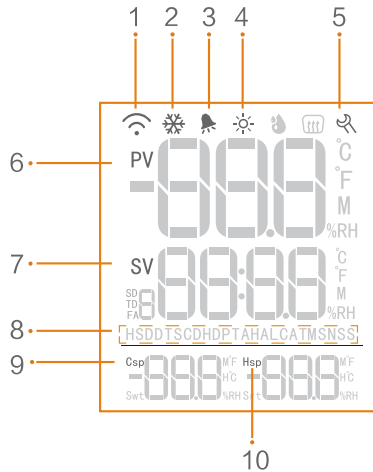

No.	Icon	Function
1		Wi-Fi Connection Status
2		Cooling Mode
3		Alarm
4		Heating Mode
5		Settings
6	PV	Current Value
7	SV	Set Value
8	Parameters	See 3.0 Parameter Instruction
9	Csp ¹	Cooling start point
10	Hsp ²	Heating start point

Note:

¹ Csp(Cooling start point) = TS(Temperature Set-point) + CD(Cooling Differential)

² Hsp(Heating start point) = TS(Temperature Set-point) - HD(Heating Differential)

2.0 Operation

 *Incorrect operation may cause serious damages to you or your device.
Please make sure you read and understand the following procedures before start.*

2.1 Probe Installation

Plug the temperature probe fully into the headphone jack from the bottom of the main controller. Otherwise, a buzzer alarm will be triggered and "Err" code will show on the LCD after powering on the controller.

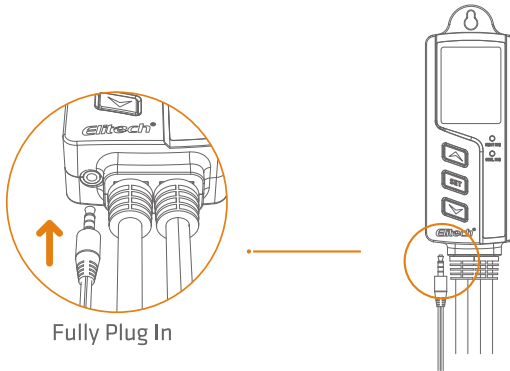

2.2 Power On

Plug the controller into a 100V to 250V power outlet, the LCD will light up and display temperature and other parameters.

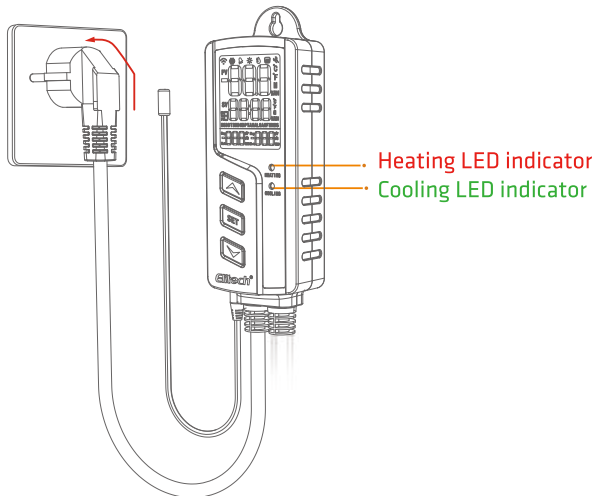

2.3 Parameter Viewing

Press or to enter **parameter viewing mode**.

Press to view the parameters and relative values in ascending order:

TS→CD→HD→PT→AH→AL→CA. The parameter details are in **2.4 Parameter Settings**.

Note: The controller will auto exit viewing mode after 5 seconds of inactivity.

2.4 Parameter Settings

STC-1000Pro supports parameter settings by buttons.

STC-1000WiFi supports parameter settings by buttons or the Elitech app.

2.4.1 Button Operation

Press and hold for 3 seconds to enter the parameter setting mode, the buzzer will beep and the LCD will display icon.

Press to switch to the next parameter, then press or to increase or decrease the setting value; or long press or to increase or decrease quickly.

Press and hold for 3 seconds to save settings and exit; or the controller will save and exit setting mode after 15 seconds of inactivity.

See the flow chart below for quick parameter setting procedures:

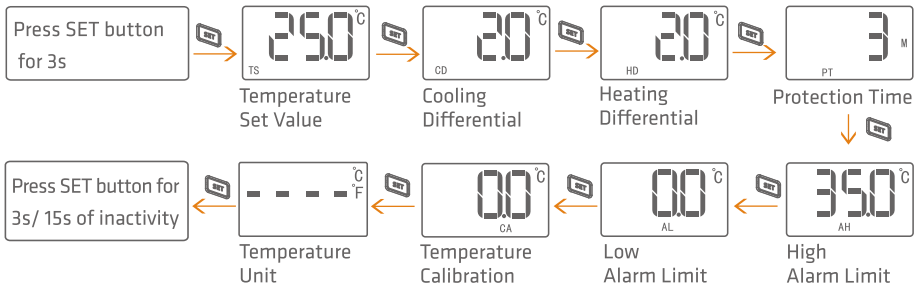

2.4.2 App Operation (STC-1000WiFi Only)

Open Elitech app, connect STC-1000WiFi to your preferred Wi-Fi to remotely view and set parameters, monitor temperature, analyze graph, export data, etc.

Further procedures are shown in **8.0 Elitech App Operation**.

3.0 Parameter Instructions

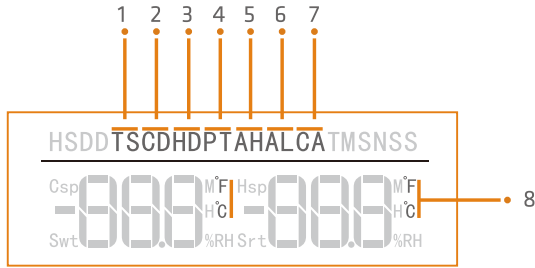

Parameter Instructions

No.	Code	Function	Setting Range	Default	Unit
1	TS	Temperature Set-point	-40 - 110	25	°C
			-40 - 230	77	°F
2	CD	Cooling Differential	0.2 - 15	2.0	°C
			1 - 30	3	°F
3	HD	Heating Differential	0.2 - 15	2.0	°C
			1 - 30	3	°F
4	PT	Protection Time	0 - 10	3	min
5	AH	High Alarm Limit	-40 - 110	35	°C
			-40 - 230	95	°F
6	AL	Low Alarm Limit	-40 - 110	0	°C
			-40 - 230	32	°F
7	CA	Temperature Calibration	-10 - 10	0	°C
			-15 - 15	0	°F
8	CF ³	Temperature Unit	°C/°F	C	---

Note: ³The °C/°F icon will flash on the LCD during temperature unit settings.

3.1 Parameter Functions

3.1.1 Temperature Setting - TS, HD, CD, PV, SV

When the controller is in normal operating status, the PV shows the current value, the SV shows the set value, by setting parameters TS (Temperature Set-point), HD (Heating Differential), and CD (Cooling Differential). It will automatically switch for the cooling and heating modes.

Cooling Mode:

- When PV (Current Value) \geq TS (Temperature Set-point) + CD (Cooling Differential), the controller enters the cooling mode, the cooling icon ❄️ and the green LED are on and the cooling outlet starts to output.

If the green LED flashes, the compressor is under protection status, please see **3.1.2 Protection Time - PT** for further information.

- When PV (Current value) \leq TS (Temperature Set-point), the controller exits the cooling mode, the cooling icon ❄️ and the green LED are off.

Heating Mode:

- When PV (Current Value) \leq TS (Temperature Set-point) - HD (Heating Differential), the controller enters heating mode, the heating icon 🔥 and the red LED are on and the heating outlet starts to output.

- When PV (Current Value) \geq TS (Temperature Set-point), the controller exits heating mode, the heating icon 🔥 and the red LED are off.

Example:

If set TS = 25°C, CD = 3°C, HD = 3°C:

Csp (Cooling start point) = TS + CD = 28°C,

Hsp (Heating start point) = TS - HD = 22°C.

When PV (current value) \geq 28°C(Csp), the controller automatically enters cooling mode. When PV \leq 25°C(TS), the controller automatically exits cooling mode.

When PV \leq 22°C(Hsp), the controller automatically enters heating mode. When PV \geq 25°C(TS), the controller automatically exits heating mode.

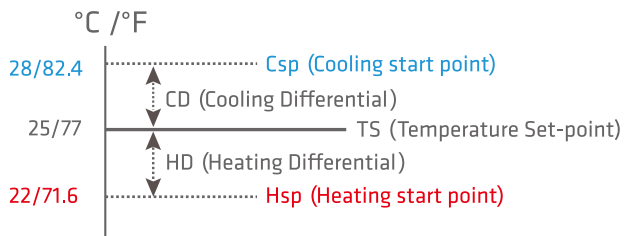
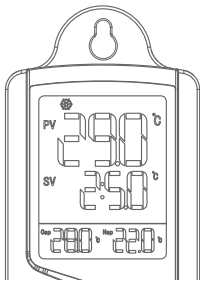

3.1.2 Protection Time - PT (Cooling Mode Only)

Frequent start/stop may influence or even shorten the service life of your appliance; we suggest you to set the parameter PT (Protection Time, i.e. cooling start delay time), to protect your appliance. Please set it according to your requirements.

Example: When PT is set to 3 minutes, PV (Current Value) > Csp (Cooling start point), the controller will enter cooling mode if either condition below is satisfied:

- The controller is powered on for more than 3 minutes;
- The interval between two adjacent cooling modes is more than 3 minutes.

3.1.3 High Alarm Limit - AH

When PV (Current Value) \geq AH (High Alarm Limit), high temperature alarm will be triggered, the LCD displays error code "EAH", the icon  and buzzer beeps promptly. Press any button to mute the buzzer, but the error code will remain until PV < AH.

3.1.4 Low Alarm Limit - AL

When PV (Current Value) \leq AL (Low Alarm Limit), low temperature alarm will be triggered, the LCD displays error code "EAL", the icon  and buzzer beeps promptly. Press any button to mute the buzzer, but the error code will remain until PV > AL.

 Note: The controller will work normally during AH or AL alarms.

3.1.5 Temperature Calibration - CA

When PV (Current Value) deviates from the standard or actual temperature, please use the parameter CA to correct it. The calibration value could be positive, 0 or negative and PV (calibrated) = PV (before calibration) + CA (temperature calibration).

3.1.6 Celsius/Fahrenheit - CF

The controller supports Celsius or Fahrenheit display. The US version default unit is in Fahrenheit, the UK/EU version default is in Celsius. If the default is different from your preferred unit, please modify the parameter CF as shown in **2.4 Parameter Settings**.

4.0 Installation



For your personal and appliance's safety, we suggest you power on the controller after the installation finishes.

This controller supports hanging-mount only, please check and confirm the installation distances and nails size before installation. The details are shown below for reference:

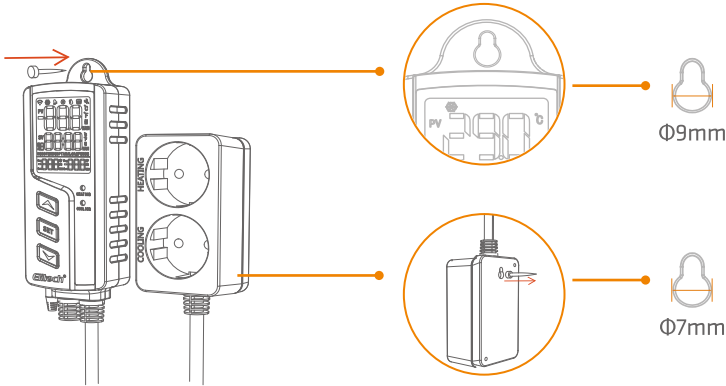

5.0 Cooling/Heating Outlet



Take care when using electricity!

Please plug your refrigeration and heating appliances into the corresponding cooling and heating outlets to the controller.

If all status is normal, the controller will start cooling or heating automatically according to the parameters, the corresponding icon, and green or red LED will show prompt to indicate the current working status.

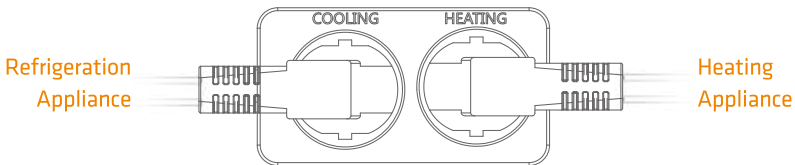

Note: If you only need to connect one appliance, or do not use the outlet for a long time, please put it away to prevent potential damage to the controller.

6.0 Error Code

If the following conditions occur, the buzzer will beep and error code will show on the LCD to alert. Press any button can mute the buzzer but error code will remain until the problems solved.

- When LCD screen displays error code “**Err**”:

The probe may be disconnected or not installed correctly. Please try to re-install the probe. If the “**Err**” code remains on the screen, please replace with a new one ASAP.

- When LCD screen displays error code “**EAH**”:

The controller is in high temperature alarm status as current temperature is above high alarm limit ($PV \geq AH$). Please check and solve it ASAP to avoid any damage or loss.

- When LCD screen displays error code “**EAL**”:

The controller is in low temperature alarm status as current temperature is below the low alarm limit ($PV \leq AL$). Please check and solve it ASAP to avoid any damage or loss.



7.0 Reset

 *Please power on the controller before reset.*

7.1 Reset to Default Parameters

Press and hold all three buttons ( +  + ) simultaneously until the screen is off. Release the buttons and the controller will auto-restart after reset to default parameters.

7.2 Reset Wi-Fi (STC-1000WiFi Only)

To reset or change the connected Wi-Fi, please press and hold  and  until the  icon flashes on the LCD.

Release the buttons and wait until  icon disappears, the Wi-Fi has reset successfully.



 *Note: Please do not cut off the power during the reset procedures.*

8.0 Elitech App Operation

STC-1000WiFi has embedded the Wi-Fi module that supports remote viewing, configuration and other operations via Elitech app.

- Download the latest Elitech app from App Store or Google Play, register your free Elitech account and sign in.
- Connect your mobile phone to preferred Wi-Fi network (2.4 GHz Wi-Fi only).
- Check the sticker on controller’s back, which should contain QR code and 20-digit GUID.

Steps:

- 1) Power on the controller, the  icon will flash on the LCD, indicate it enters pairing mode.
- 2) Click top right  icon at home page of Elitech app, to enter **Add Device** page.

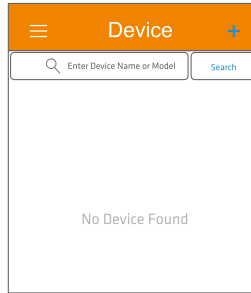

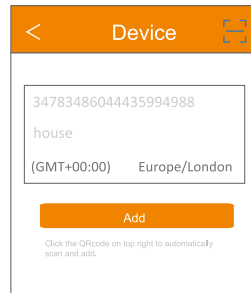

- 3) Scan or type in the device GUID and device name, then click **Add**.

Note: Click top right  icon to scan the QR code or manual type in the 20-digit numbers on the sticker.

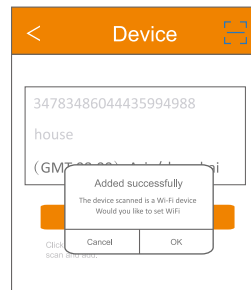

- 4) When prompted as **Added successfully**, click **OK** to continue Wi-Fi configuration.



5) The app will recommend a Wi-Fi network your mobile phone is already connected to. If this is the Wi-Fi network you would like to use, please enter your Wi-Fi password and click **Entered Configuration** and wait for about 30 seconds. The app should return to home page and the controller should show as "online" and the solid  icon will also show on the LCD.

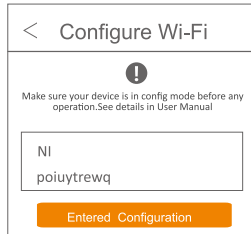

*Note: The controller will remain discoverable for 30 minutes after being powered on; the configuration may fail if it lasts longer than that. To retry, just power off and on again or follow **7.2 Reset Wi-Fi** to restore the Wi-Fi status.*

9.0 Specifications

Power supply: 100~250VAC, 50/60Hz

Total power consumption: <5W

Temperature measuring range: -45°C ~115°C/-49°F~239°F

Temperature control range: -40°C~110°C/-40°F~230°F

Temperature resolution: 0.1°C/0.1°F

Temperature accuracy: ±1°C/±2°F

Operating ambient temperature: -10°C~65°C/14°F~149°F

Storage temperature: -20°C~75°C/-4°F~167°F

Relay contact output rating: 10A res. @ 100 ~ 250VAC

Maximum Power: 1100W @ 110V/2200 W @ 220V

Probe type: NTC (10KΩ/25°C, B value = 3435K)

Cable length (Probe): 2m

Cable length (Power plug): 1.5m

Cable length (Heating/Cooling Outlet): 0.3m

Dimensions: 165 x 60 x 32 mm

Best LCD screen viewpoint: 6 o'clock position

Wi-Fi type: 2.4GHz Wi-Fi (STC-1000WiFi Only)